

# STONE VASO SOSPESO SENZABRIDA®

STS05.BI

CE EN 997:2015

# GLOBO

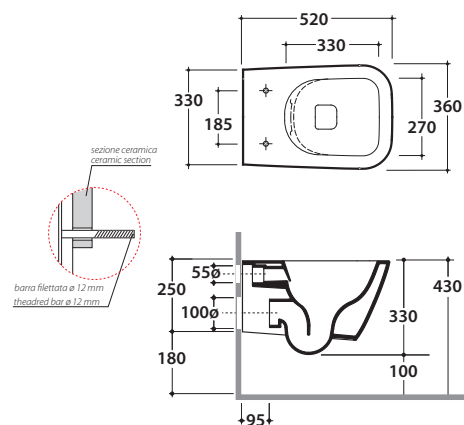

Effetto antibatterico su ceramica BATAFORM®  
Ceramic antibacterial effect BATAFORM®



Bagno di Colore



SENZABRIDA®



Prodotto smaltato con CERASLIDE®  
Glazed product with CERASLIDE®



Scarico ottimizzato a 4/2,6 litri  
Drain 4/2,6 lt.

Cod. **STS05.BI**

Vaso sospeso SENZABRIDA® 52.36 h33 cm. Scarico 4 / 2,6 Lt. Completo di fissaggi. Peso 21 Kg

Wall-hung Wc No rim 52.36 h33 cm. Drain 4 / 2,6 Lt. Fixing kit included. Weight 21 Kg

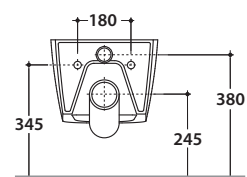

Copriwater con sistema di cerniere a sgancio rapido  
Seat-cover with hinge system to quick release



Trattamento antibatterico per sedili in versione bianco lucido  
Antibacterial treatment on toilet seats in shiny white

Cod. **ST021BI**

Coprivaso rimovibile in duroplast con chiusura tradizionale. Peso 3,5 Kg

Removable duroplast seat-cover with traditional closing system. Weight 3,5 Kg

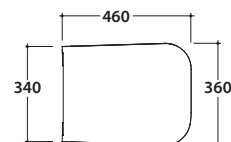

Cod. **ST022BI**

Coprivaso rimovibile in duroplast con chiusura rallentata. Peso 3,5 Kg

Removable duroplast seat-cover with soft-closing system. Weight 3,5 Kg

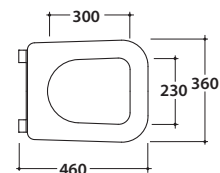

Cod. **VA132**

Riduttore flusso di scarico.

Flow reductor.



Cod. **PU001**

Protezione antiurto e acustica.

Acoustic and crash protection.



Cod. **FI002**

Staffa di fissaggio a "L". Peso 2,5 Kg

Fixing brackets for W/H sanitary. Weight 2,5 Kg

# STONE BIDET STS10.BI

# GLOBO

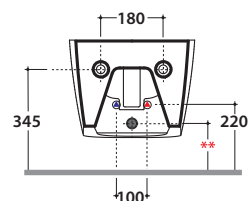
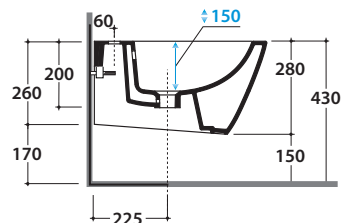
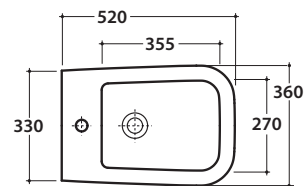
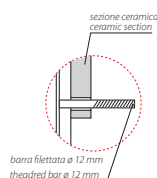

## Cod. STS10.BI

Bidet sospeso 52.36 cm . Con sistema di fissaggio dal basso nascosto.

Completo di fissaggi. Peso 20 kg

Wall-hung bidet 52.36 cm. Provided with lower hidden fixing system.

Fixing kit included. Weight 20 kg.

\*\* per installazione con / for installation with:  
-sifone a "S"/siphon "S": mm 160  
-sifone SF052/siphon SF052: mm 140



## Cod. FI002

Staffa di fissaggio a "L". (Barra filettata ø12). Peso 2,5 kg.

Fixing brackets for W/H sanitary. The thread bar ø 12. Weight 2,5 kg.

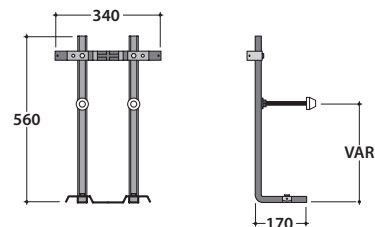

## Cod. PU001

Protezione antiurto e acustica. Peso 0,2 kg.

Acoustic and crash protection. Weight 0,2 kg.