

# 4ALL VASO MDS02.BI

# GLOBO

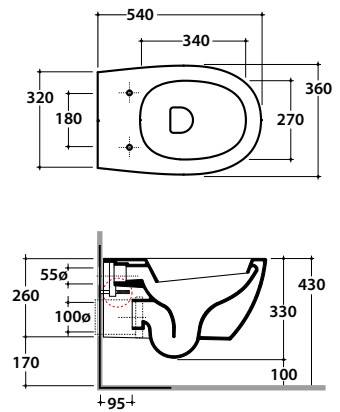

Cod. **MDS02.BI**

Vaso sospeso con sistema di fissaggio dal basso nascosto.

Scarico 4,5/3 Lt. Peso 18 kg.

Wall-hung pan provided with lower hidden fixing system. Drain 4,5/3 Lt.

Weight 18 kg.

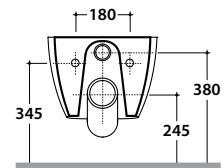

Cod. **MD019BI**

Coprivaso in termoindurente. Peso 3 kg.

Thermo-setting seat-cover. Weight 3 kg.

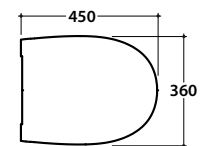

Cod. **MD020BI**

Coprivaso in termoindurente chiusura rallentata. Peso 3 kg.

Thermo-setting seat-cover with soft-closing system. Weight 3 kg.

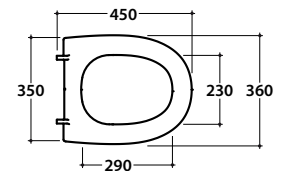

Cod. **VA132**

Riduttore flusso di scarico.

Flow reductor.



Cod. **FI002**

Staffa di fissaggio a "L". (Barra filettata  $\phi$ 12). Peso 2,5 kg.

Fixing brackets for W/H sanitary. Threaded bar  $\phi$  12. Weight 2,5 kg.

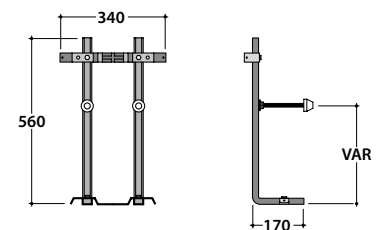

Cod. **PU001**

Protezione antiurto e acustica. Peso 0,2 kg.

Acoustic and crash protection. Weight 0,2 kg.

# 4ALL BIDET MDS09.BI

# GLOBO

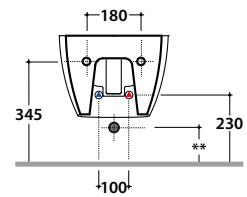
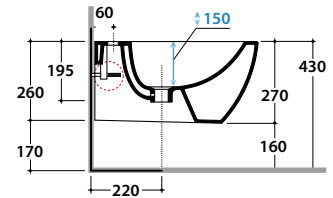
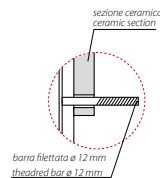
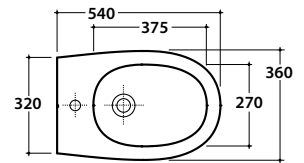

\*\* per installazione con / for installation with:  
-sifone a "S"/siphon "S": mm 140  
-sifone SF052/siphon SF052: mm 120

Cod. **MDS09.BI**

Bidet sospeso monoforo con sistema di fissaggio dal basso nascosto.

Peso 17 kg.

Wall-hung bidet one hole provided with lower hidden fixing system.

Weight 17 kg.



Cod. **FI002**

Staffa di fissaggio a "L". (Barra filettata ø12). Peso 2,5 kg.

Fixing brackets for W/H sanitary. Threaded bar ø 12. Weight 2,5 kg.

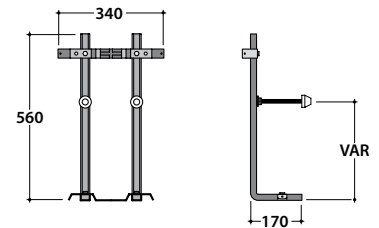

Cod. **PU001**

Protezione antiurto e acustica. Peso 0,2 kg.

Acoustic and crash protection. Weight 0,2 kg.