

# STOCKHOLM LAVABO LA084.BI

CE EN 14688:2015

# GLOBO



Effetto antibatterico su ceramica  
BATAFORM®  
Ceramic antibacterial effect  
BATAFORM®



Prodotto smaltato con  
CERASLIDE®  
Glazed product with  
CERASLIDE®

Cod. **LA084.BI**

Lavabo 84.45 h 13 cm. Installazione sospesa. Completo di fissaggi. Peso 20 Kg  
Basin 84.45 h 13 cm. Wall-hung installation. Fixing kit included. Weight 20 Kg

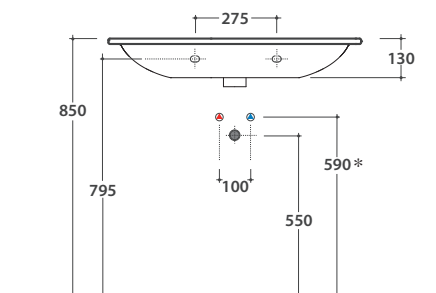
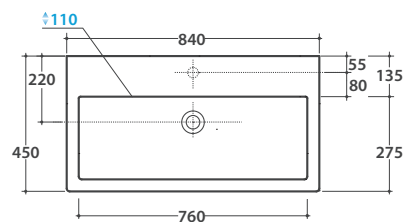

\* Per rubinetto su piano / For taps mounted on counter top



Cod. **FI012BI**

Piletta up and down con tappo in ceramica per lavabi con troppo pieno. Peso 0,5 Kg  
Push open valve drain with ceramic top for basins with overflow. Weight 0,5 Kg



Cod. **FI012CR**

Piletta cromata up and down per lavabi con troppopieno. Peso 0,5 Kg  
Push open chromed valve drain for basins with overflow. Weight 0,5 Kg

Cod. **LAST084CR**

Struttura a terra 81.43 h 71 cm in ottone cromato con ripiano in vetro verniciato bianco.  
Peso 8,8 Kg  
Brass chromium-plated floor-mounted structure with white painted glass shelf 81.43 h 71 cm.  
Weight 8,8 Kg

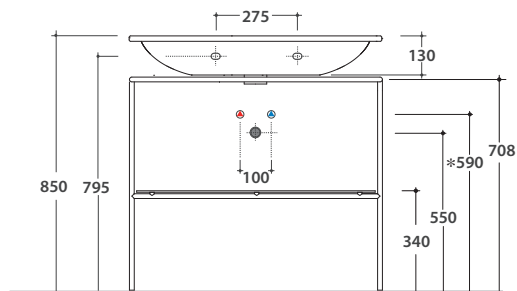
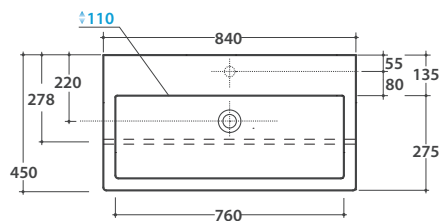
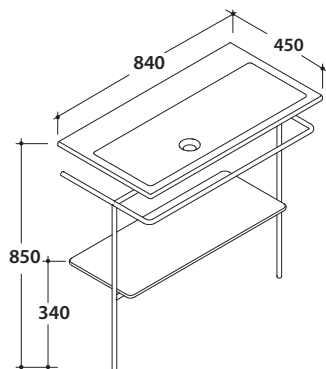

\* Per rubinetto su piano / For taps mounted on counter top