

Dati Tecnici - Technical Data - Technische Daten - Datos Tecnicos - Données Techniques

Peso netto - Net weight - Nettogewicht - Peso neto - Poids net

15 Kg

Caratteristiche Idrauliche - Hydraulic Features - Hydraulische Eigenschaften
Características Hidráulicas - Caractéristiques Hydrauliques

Capacità (al troppo pieno) - Capacity (to overflow) - Wasserkapazität (zum überlaufen) - Capacidad (al rebosadero) - Capacité (au trop plein)

128 l

Dimensioni dell'attacco sulla colonna di scarico - Socket dimensions on drainage column - Masse des Anschlüsse am Abflussrohr - Dimensiones de la conexión en la columna de desagüe - Dimension du raccord de la colonne de vidage

1 1/2"

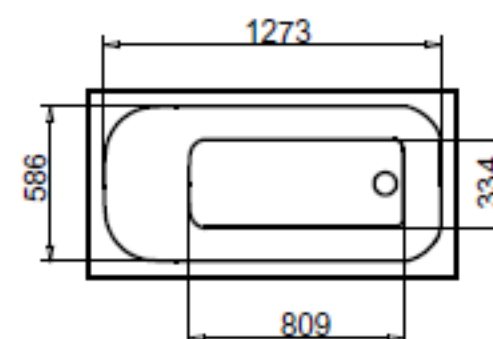
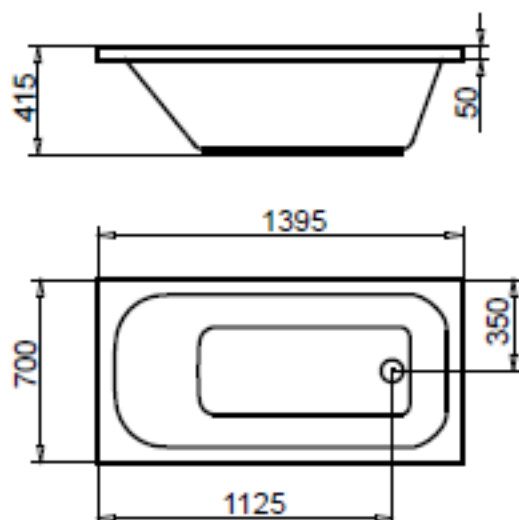

predisposizioni - arrangements - installationsvorbereitung - predisposición - prédisposition

installazione a sinistra - left installation

Installation nach links - instalación a la izquierda - montage à gauche

installazione a destra - right installation

Installation nach rechts - instalación a la derecha - montage à droite

